

D-SERIES

Strong . Attractive . Flexible . Durable
Easy to Install . Cost Effective



YUNG KONG VERSATILE FENCE SDN BHD

197401002499 (19842-P)

Lot 114A, Jalan Kemajuan, Pending Industrial Estate,
93450 Kuching Sarawak, Malaysia.

Tel
Fax
Website

8 082-484327
8 082-337177
8 www.ykmggroup.my





PRODUCT SPECIFICATION SHEET (D-SERIES)

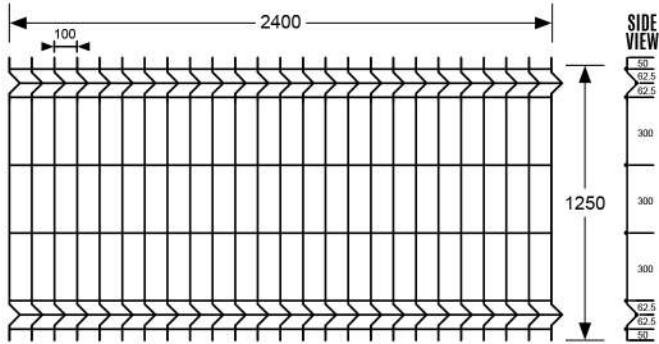

WIRE DIAMETER (mm)	5
HEIGHT (mm)	1250
WIDTH (mm)	2400
SPACING (mm)	100 X 300
COATING	HEAVY G.I

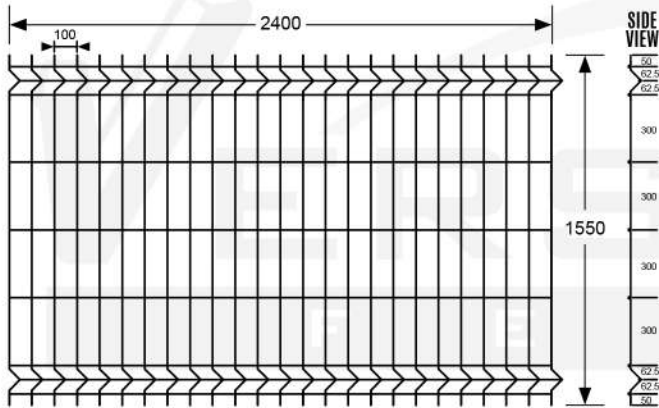

WIRE DIAMETER (mm)	5
HEIGHT (mm)	1550
WIDTH (mm)	2400
SPACING (mm)	100 X 300
COATING	HEAVY G.I

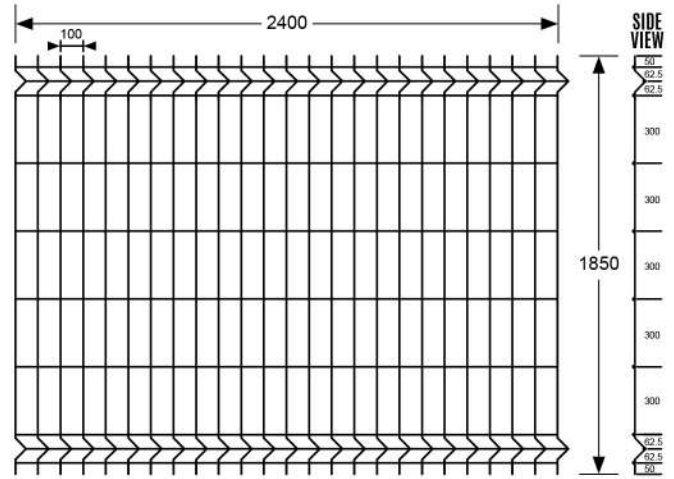

WIRE DIAMETER (mm)	5
HEIGHT (mm)	1850
WIDTH (mm)	2400
SPACING (mm)	100 X 300
COATING	HEAVY G.I

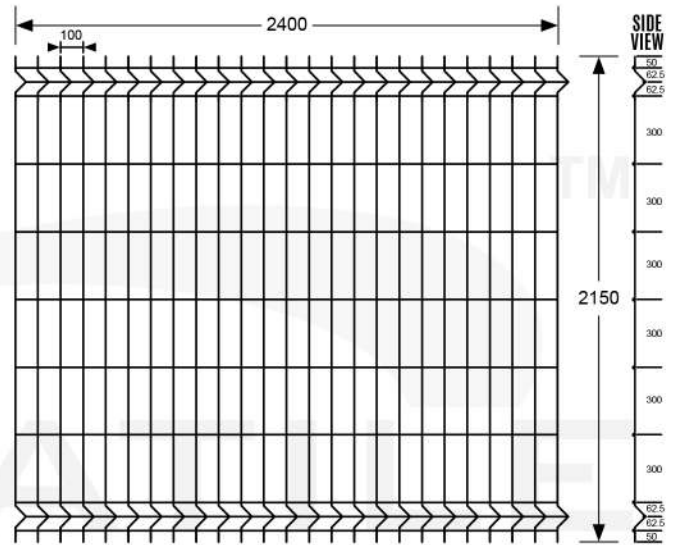

WIRE DIAMETER (mm)	5
HEIGHT (mm)	2150
WIDTH (mm)	2400
SPACING (mm)	100 X 300
COATING	HEAVY G.I

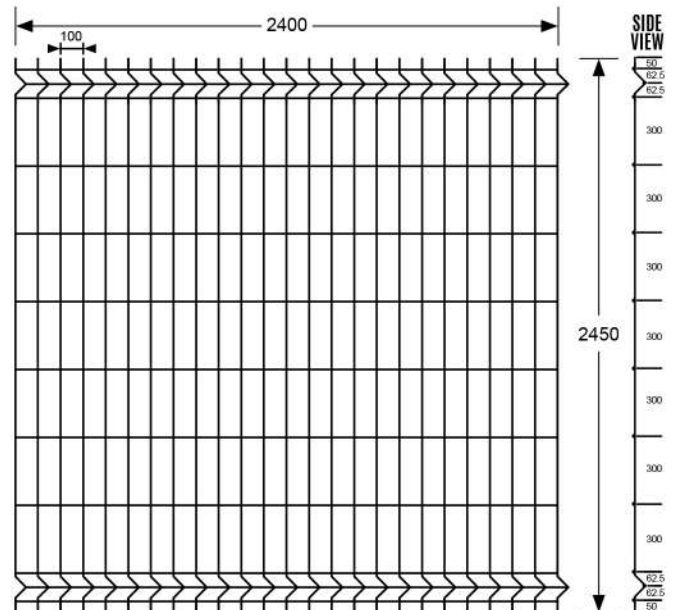

WIRE DIAMETER (mm)	5
HEIGHT (mm)	2450
WIDTH (mm)	2400
SPACING (mm)	100 X 300
COATING	HEAVY G.I

DETAIL A

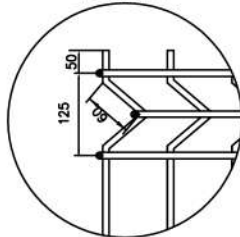

SIDE VIEW

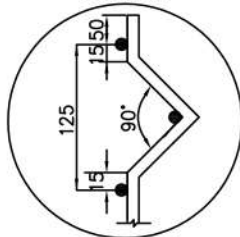

NOTE:
1. Minimum zinc coating 245g/m²

